

EZM0112QFN4 ZBD Schottky Detector

0.1-12.0 GHz Power Monitor, Network Matched



Technical Characteristics

Product Features

No bias required
Neg. (-) Polarity
Broadband Flat Frequency Response
Excellent VSWR
Low Cost QFN 4mm leadless RoHS package

Max. Ratings

Storage Temperature:	-65° to +125°C
Operating Temperature:	-45° to +95°C
Maximum input power:	+27dBm peak, +20dBm CW
Specifications	@ +25° & -20 dBm Input Power

Electrical Specifications

Parameters	Freq. (GHz)	Min.	Typical	Max.	Units
Voltage Sensitivity	0.1 to 12.0	400	500	600	mV/mW open circuit
Voltage Sensitivity Stability over Temperature	0.1 to 12.0	2.5	3	3.5	dB
VSWR	0.1 to 12.0		1.5:1	1.8:1	
Flatness	0.1 to 12.0		+/-0.50	+/-0.80	dB
Polarity			Neg. (-)		eV
Video Capacitance		10	20	30	pF (Note 3)
Dynamic Range	0.1 to 12.0	-30		20	dBm
Tss			-		

NOTES:

1. Negative output polarity is standard, Add "P" to the end of the model number for positive polarity, Ex: EZM0112PQFN4.
2. Typical values are measured at +25°C and are not guaranteed.
3. External bypass capacitor is required for operation below 2 GHz.
4. Pins 4&5 - RF Input, Pins 15&16 - Video Output

PACKAGE PINOUT

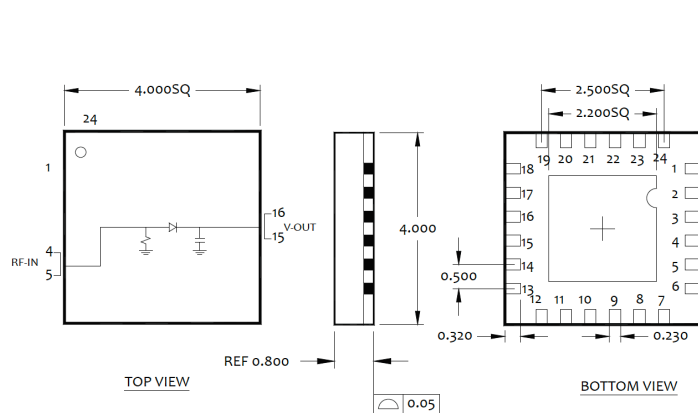

RECOMMENDED PCB LAYOUT

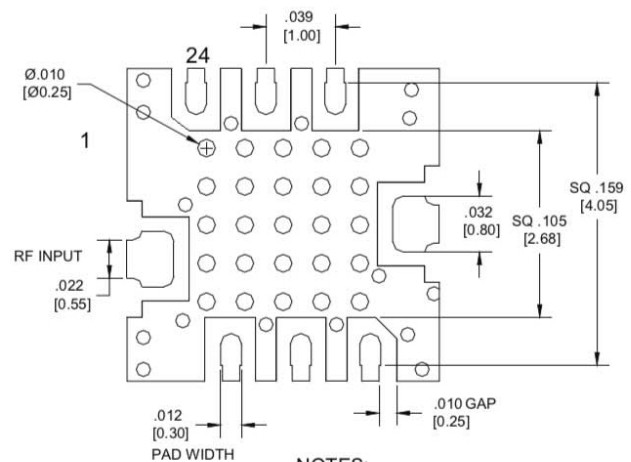

NOTES:

1. MATERIAL: ROGERS 4350, 10 MIL THICK
2. DIMENSIONS ARE IN INCHES[MM]

EZM0112QFN4 ZBD Schottky Detector

0.1-12.0 GHz Power Monitor, Network Matched



Data Plots

