

EQN0818-06 Negative Slope Equalizer

8.0 to 18.0 GHz



Technical Characteristics

Product Features
Fixed or adjustable attenuation tuning
Low insertion loss
SMA connector standard
Impedance 50 or 75 ohms
Compact size
Meets MIL-E-5400 and MIL-E-16400 environmental requirements

Maximum Ratings	
Max. Input Power	150mW
Operating Temperature	-55 to +95°C
Storage Temperature	-65 to +125°C
Specifications @	25°C

Maximum Ratings
ECCN: EAR 99 (Unless otherwise specified)
HTS: 8543.7080.00

Parameters	Freq. (GHz)	Minimum	Typical	Maximum	Units	Conditions
Attenuation	8.0 to 18.0		6.0		dB	
Insertion Loss	18.0		1.0		dB	
VSWR	8.0 to 18.0		1.8:1			
Linearity	8.0 to 18.0		+/-0.5		dB	
Max. Input Power	8.0 to 18.0			150	mW	

Package Outline: Q

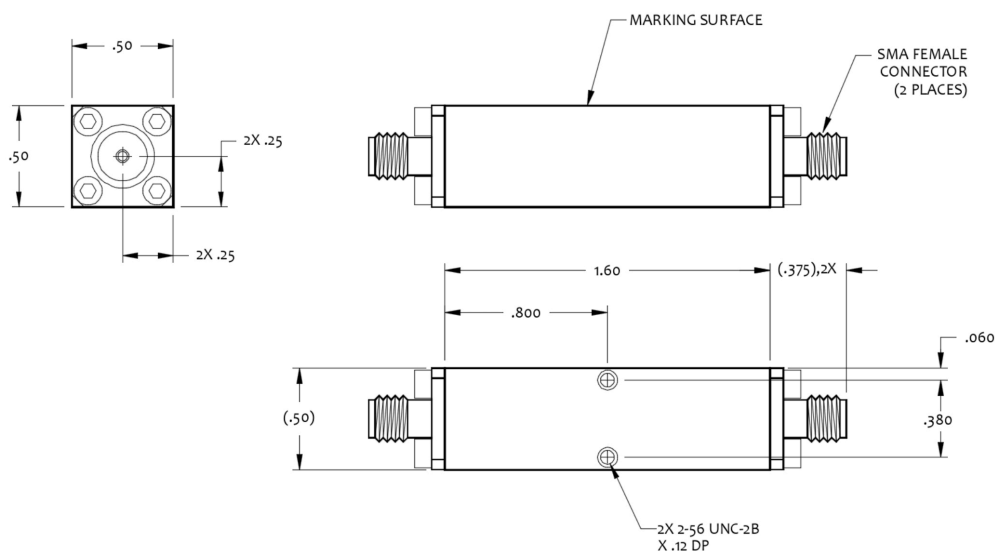

DISCLAIMER: Subject to change without notice.
Rev(B) 09/12/19

EQN0818-06 Negative Slope Equalizer

8.0 to 18.0 GHz



Test Data

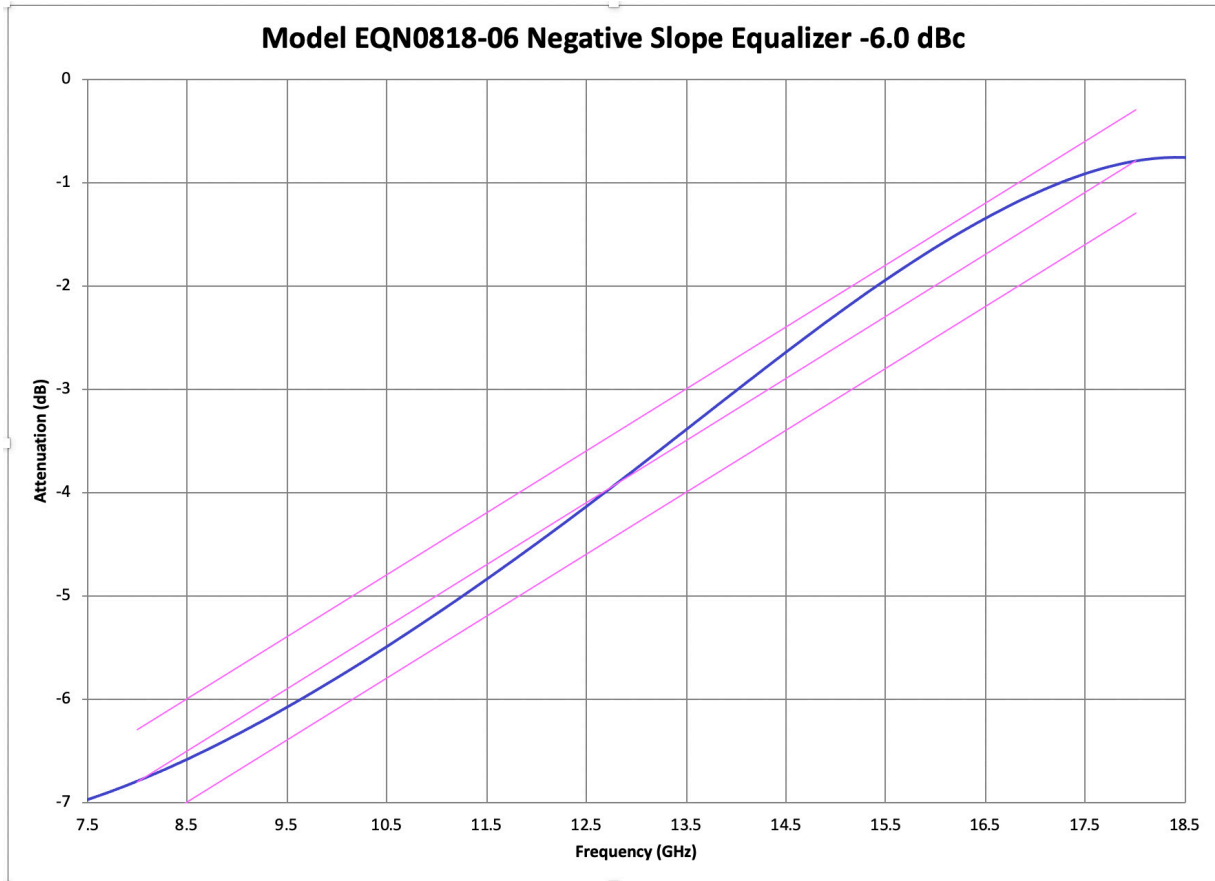

DISCLAIMER: Subject to change without notice.
Rev(B) 09/12/19